

BLACKHAWK®



Porto-Power®



65132A



4-Ton Standard Set

ensemble standard
pousseur 4 tonnes

Standard Satz 4 T

4 Ton standaard set

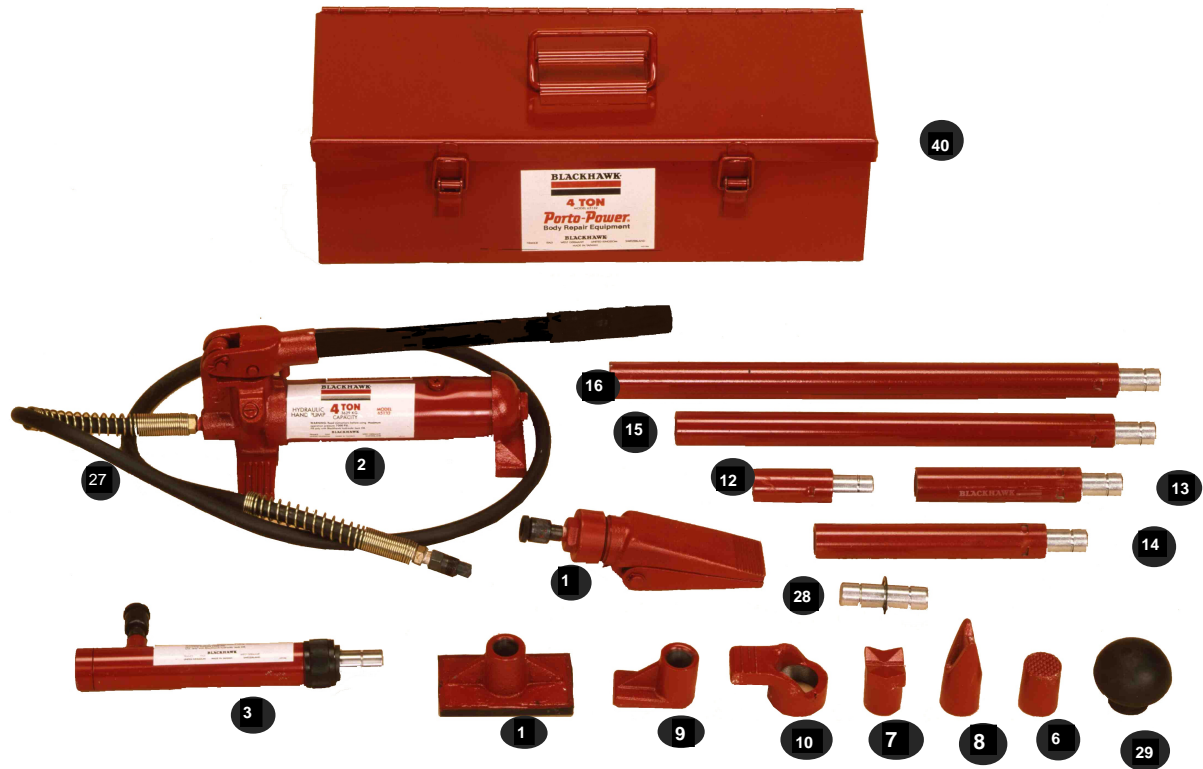

65135A



10 Ton Set

Ensemble vérin 10t

10 T Satz

10 Ton set

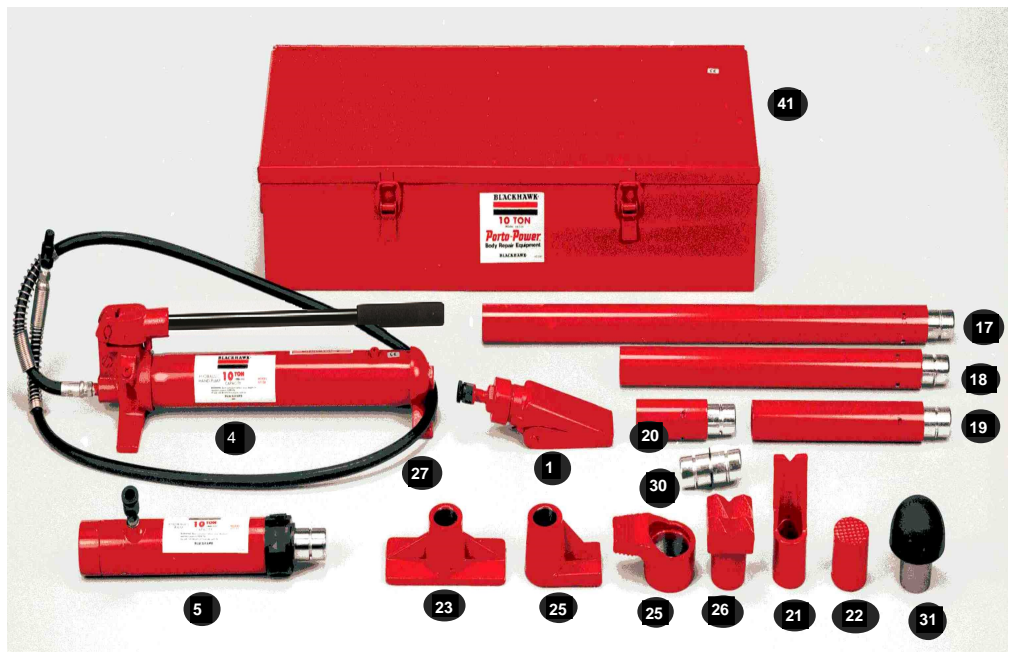

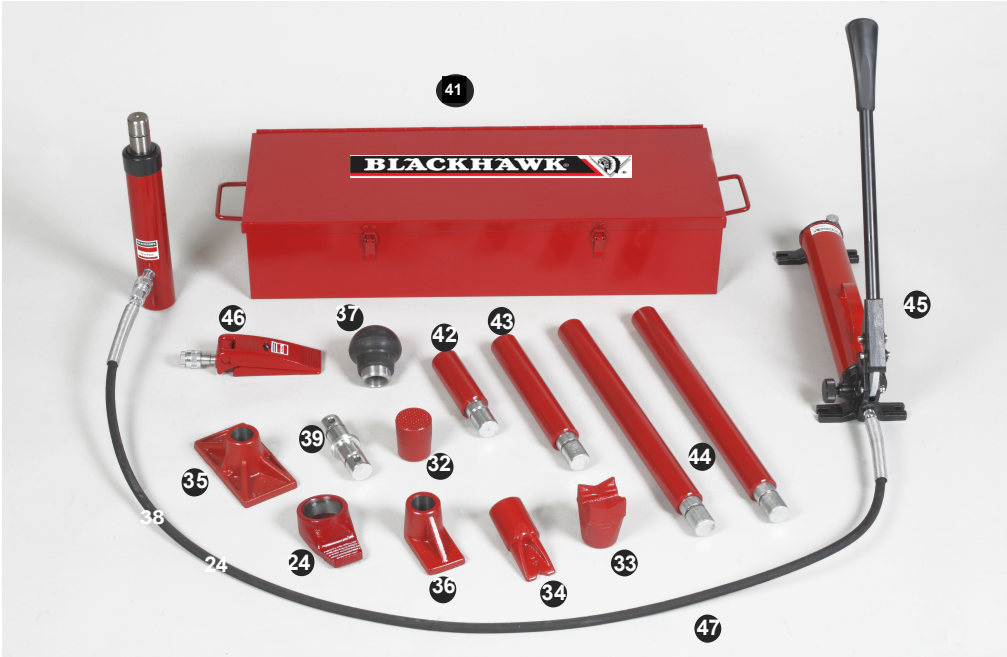

65135A
65132A SF181A

1	65123A	1	1
2	65133A	1	
3	65134A	1	
4	65136A		1
5	65137A		1
6	65151	1	
7	65152	1	
8	65153	1	
9	65154	1	
10	65155	1	
11	65156	1	
12	65157	1	
13	65158	1	
14	65159	1	
15	65160	1	
16	65161	1	
17	65162		1
18	65163		1
19	65164		1
20	65165		1
21	65166		1
22	65167		1
23	65168		1
24	65169	1	1
25	65172		1
26	65173		1
27	65176C	1	1
28	65177	1	
29	65178	1	
30	65179		1
31	65180		1
32	65637		1
33	65138		1
34	65139		1
35	65640		1
36	65642		1
37	65667		1
38	ARC157		1
39	FZ.1050		1
40	H 31614	1	
41	H 31693A		1
42	K 239 900		1
43	K 240 900		1
44	K 241 900		2
45	PMP 7600		1
46	SA 4		1
47	Z913		1

SF 181A

10 Ton Porto Power Set
Upon request, this can be delivered with air-hydraulic pump PMP8111.

Ensemble pousseur 10 tonnes à raccords rapide sans filetage.
L'ensemble SF181A peut être livré sur demande avec une pompe hydro-air PMP8111.

Porto Power Satz 10T. Standard Grundausrüstung.
Satz kann auf Anfrage mit einer lufthydraulischen Pumpe PMP8111 geliefert werden.

10-Ton Porto Power set met snelle aansluitingen zonder schroefdraad.
De SF181A set kan op aanvraag geleverd worden met een hydro-lucht pomp PMP8111

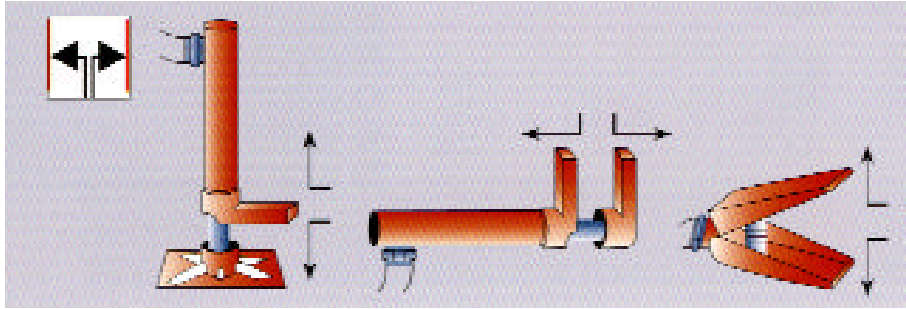
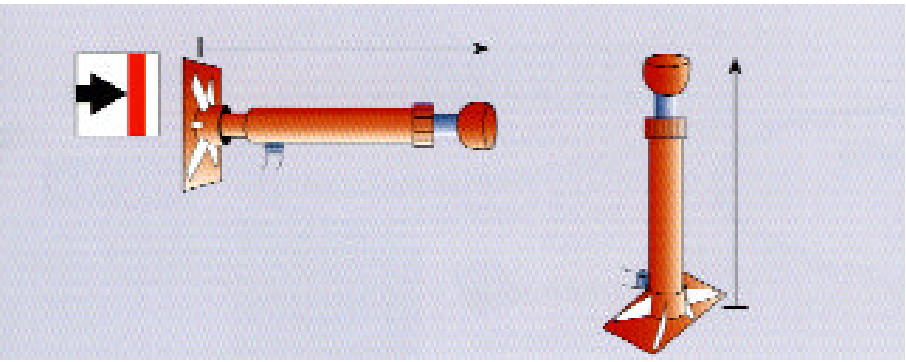

ARC1740

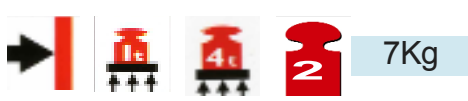

ARC1740		
1	ARC1731	2
2	ARC1710	1
3	ARC1732	1
4	ARC1722	1

4 Ton Pull Ram Set

Quick chain anchoring used with pumps PMP7610, PMP8110

Ensemble tireur 4 tonnes

Verrouillage rapide des chaînes. S'utilise avec les pompes PMP7610, PMP8110.

Standard Zugsatz 4T

Mit PMP7610 Handpumpe und PMP8110 lufthydraulische Pumpe

4-Ton Traction set

met snelle afgrenzeling van de kettingen. Wordt gebruikt met pompen PMP7610 et PMP8110

ARC1730

Similar 4 Ton pull set with ARC1720 ram. Used with 65136A pump.

Ensemble tireur 4 tonnes similaire avec vérin ARC1720. S'utilise avec pompe 65136A.

Ähnlicher Zugsatz 4T mit Zylinder ARC1720. Mit Pumpe 65136A anwendbar.

Gelijksortige 4-Ton traction set met Porto-Power ARC1720. Wordt gebruikt met pomp 65136A.

ATZ 20B



20 Ton standard Set

Ensemble standard 20 tonnes

Standard Satz 20T

20 ton Standaard Set.

ATZ 21A

ATZ 20B

1	PMP7610	1	
2	RC 250	1	1
3	Z 239	1	1
4	Z 242	2	3
5	Z 436	2	2
6	Z 669	1	1
7	Z 595		1
8	Z 1041	1	1
9	Z 1042	1	1
10	Z 1043	1	1
11	P420H		1
12	Z 1046		1
13	Z 1047		1
14	Z 218		2
15	Z 241		1
16	Z 243		1
18	Z 238		1
19	Z 607		1

ATZ 21 A



20 Ton Set

Ensemble 20 tonnes

Satz 20T

20 ton Set.

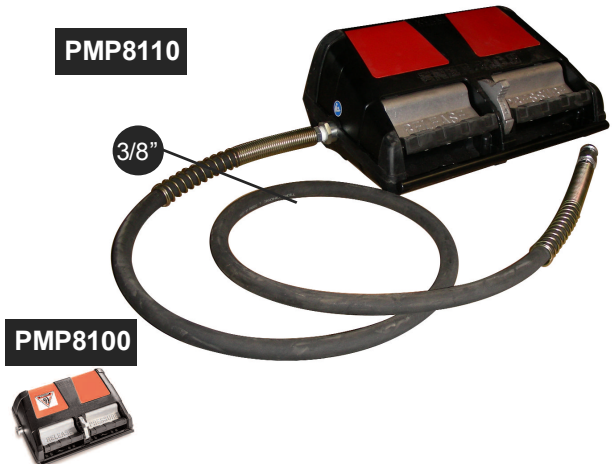
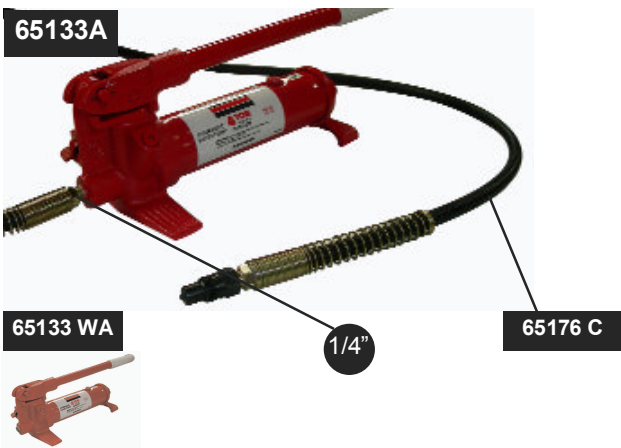
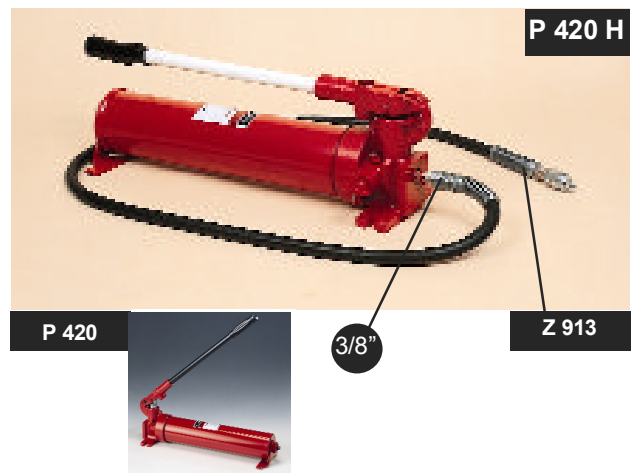
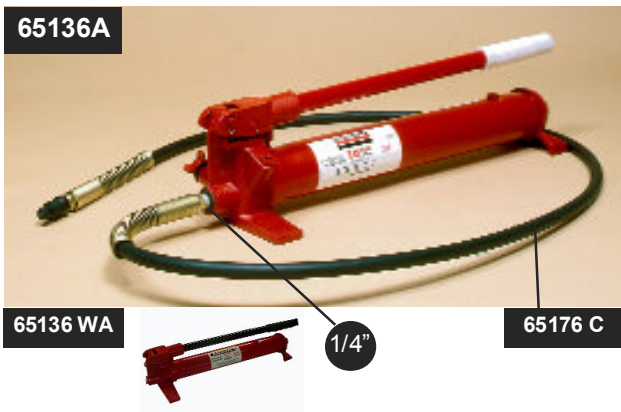
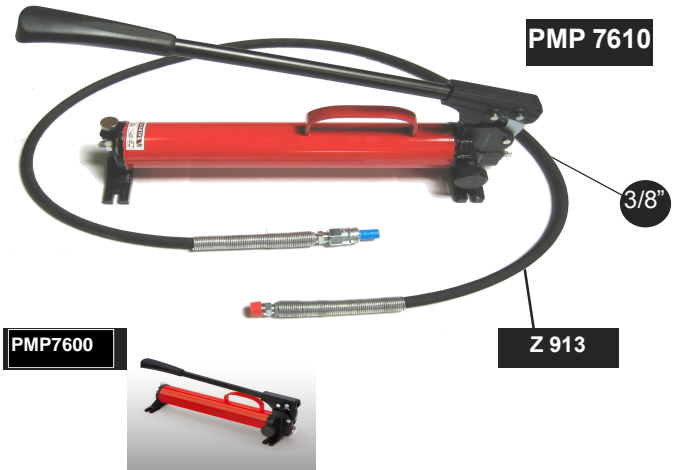















65126 WA	700 bar	638cm ³	6.8Kg
65133 WA	500 bar	400cm ³	4.7Kg
65136 WA	600 bar	638cm ³	6.8Kg
PMP7600	700 bar	770cm ³	6.2Kg
P 420	700 bar	2300cm ³	12.5Kg
PMP8100	700 bar	1000cm ³	8.6Kg

Rams

Vérins

Zylinder

Cylinder

							
							
	H68939	ZR400	H68939	ZR400	ZR400	ZR400	ZR400
	65134A	ARC 102	65137A	ARC 157	RC 159	ARC 161	ARC 1610
	1/4"	3/8"	1/4"	3/8"	3/8"	3/8"	3/8"
max mm	117 mm	57 mm	152 mm	152 mm	152 mm	250 mm	250 mm
min mm	279 mm	118 mm	304 mm	370 mm	298 mm	402 mm	545 mm
mm	38 mm	57 mm	57 mm	57 mm	57 mm	57 mm	57 mm
cm ³	84 cm ³	82 cm ³	237 cm ³	220 cm ³	220 cm ³	366 cm ³	366 cm ³
bar	600 bar	700 bar	670 bar	700 bar	700 bar	700 bar	700 bar



3/8"	3/8"	3/8"	1/4"	3/8"	3/8"
250 mm	16 mm	129 mm	165 mm	141 mm	142 mm
480 mm	41 mm	287 mm	280 mm	303 mm	303 mm
57 mm		86 mm	84 mm	57 mm	57 mm
366 cm ³	16.4 cm ³	430 cm ³	524 cm ³	103 cm ³	104 cm ³
700 bar	700 bar	700 bar	680 bar	700 bar	700 bar

Spreaders

Ecarteurs

Spreizer

Uitduwer

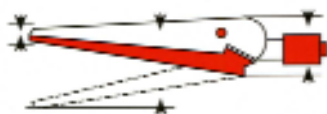
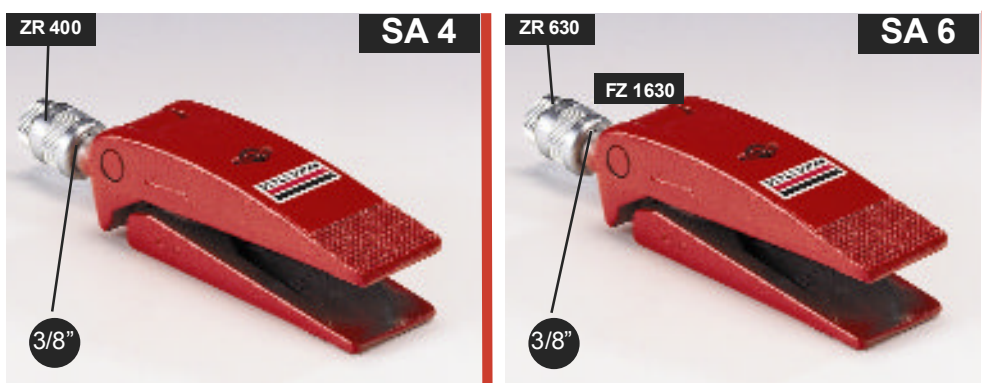
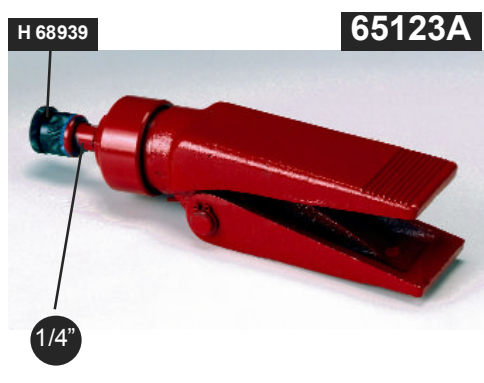
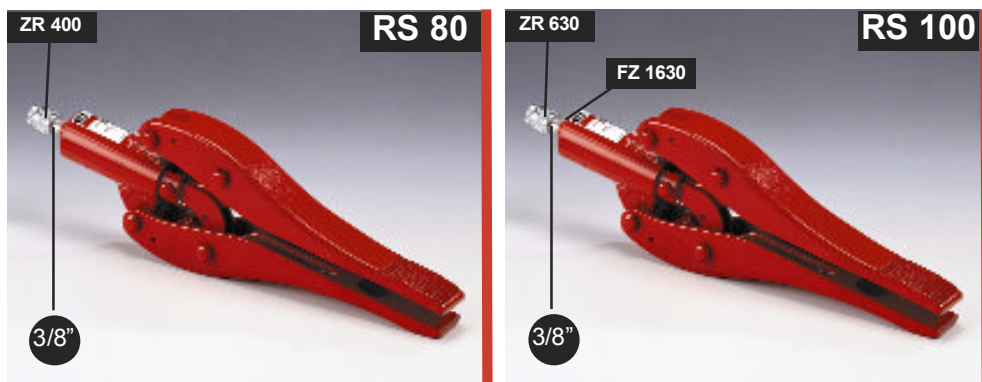

RS80	32 mm	292 mm	157	700 bar	63.8 cm ³
RS100	32 mm	292 mm	157	700 bar	63.8 cm ³
65123A	15 mm	75 mm	50	580 bar	10 cm ³
SA4	10 mm	95 mm	51	700 bar	10.6 cm ³
SA6	10 mm	95 mm	51	700 bar	10.6 cm ³

Hoses and couplers

Flexibles et raccords

Schläuche und Schnellkupplungen

Slangen en fittingen

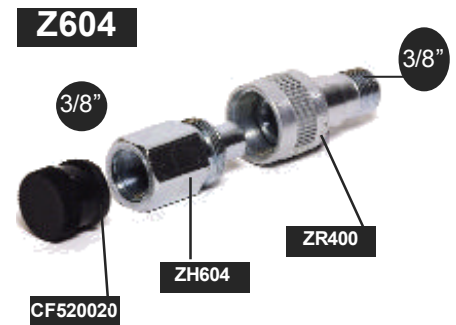
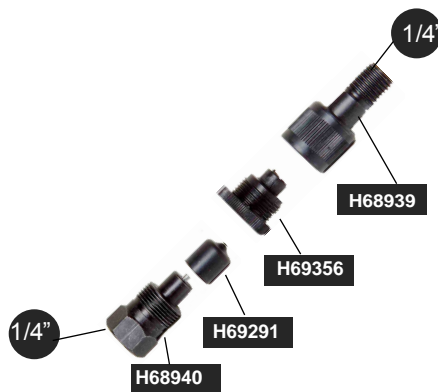
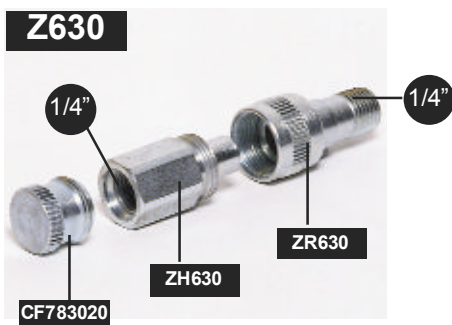
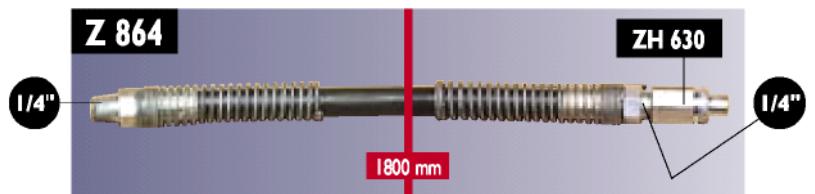
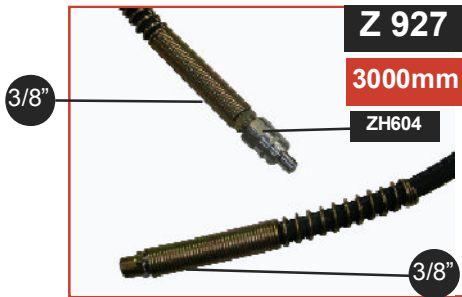
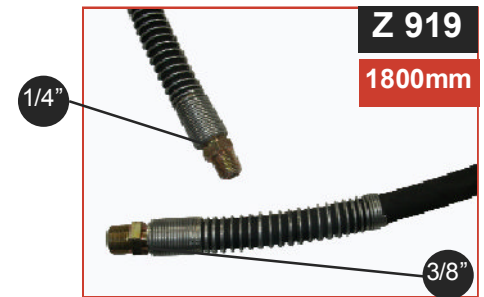
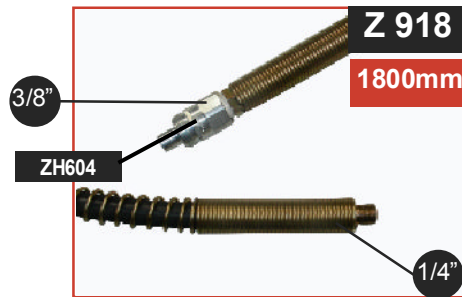
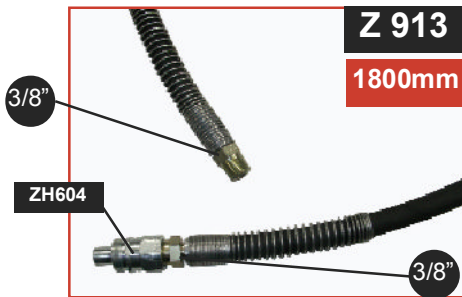
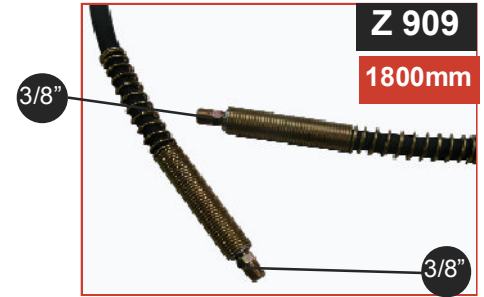
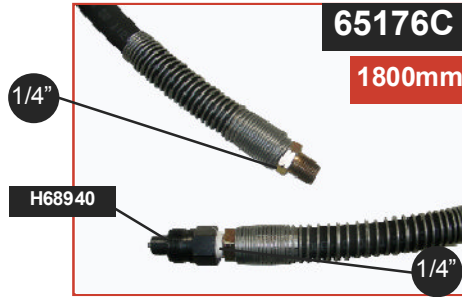
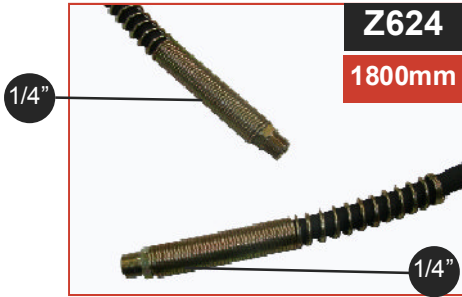

Gauges and Couplers

Manomètres et raccords

Manometer und Anschlußstücke

Manometers en aansluitingen



V 82

Shut off valve

Robinet coupe-circuit

Absperrventil. Kann auch als Drosselventil verwendet werden.

Afsluitkraan



AGA 1

Gauge adaptor / 70 mm length / for pump and hose

Adaptateur / longueur totale 70mm / sur pompe et flexible

Anschlußstück für Manometer / Gesamtlänge 70mm / auf Pumpe und Schlauch

Adapter / totale lengte 70 mm / voor pomp en buigbaar

PMP7600
PMP8131
P420 H

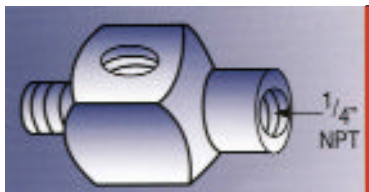

AGA 3

Gauge adaptor for pumps

Adaptateur / sur pompe et flexible

Anschlußstück für Manometer für Pumpen

Adapter / voor pompe en buigbaar

65126A
65136A



AGA 21

Gauge adaptor /155 mm length / for pump and hose

Adaptateur / longueur totale 155 mm / sur pompe et flexible

Anschlußstück für Manometer / Gesamtlänge 155 mm / auf Pumpe und Schlauch

Adapter / totale lengte 155 mm / voor pomp en buigbaar

PMP7600
PMP8131
P420 H

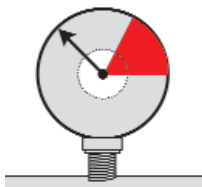

AGF 10S

AGF 7000

AGF23S

Hydraulic pressure gauge 700 bars

Manomètre hydraulique 700 bars.
Manometer für zylinder 700 bars
700 bars hydraulische manometer

Hydraulic pressure gauge 700 bars.

Manomètre hydraulique 700 bars.
Manometer für zylinder 700 bars
700 bars hydraulische manometer

Hydraulic pressure gauge 700 bars
Manomètre hydraulique 700 bars
Manometer für zylinder 700 bars
700 bars hydraulische manometer

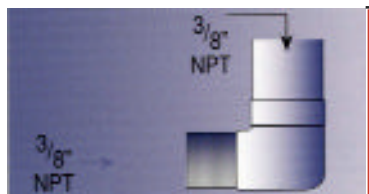

FZ 1616

Elbow

Coude

Winkel

Kromme buis

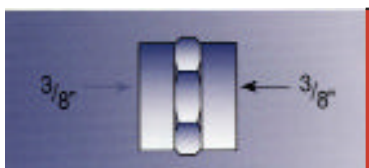

FZ 1614

Female coupling

Coupleur femelle

Verbindungsmuffe

Contra verbinding

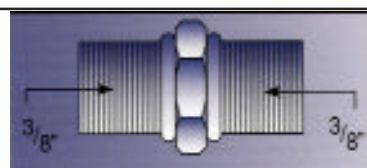

FZ 1617

Hex nipple

Coupleur mâle

Sechskantgewindehülse

Verbinding

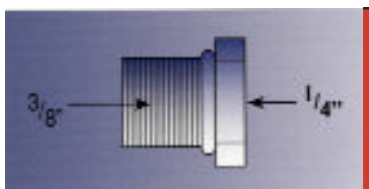

FZ 1630

Reducer bushing

Raccord réducteur

Reduzierung

Reducerende verbinding







Attachments for use with 4 - 10 - 20T hydraulic rams
 Accessoires utilisables avec les vérins 4, 10 et 20 tonnes.
 Zubehör für Ausführungen 4T, 10T, 20T
 Accessoires voor 4, 10, en 20 ton tractie-uitrustingen



		65177	FZ 1050	FZ 1050	65179	
	Tube connector Raccord d'accouplement Rohrverbindung Buisadapter					
	Male adaptor threaded Raccord d'accouplement fileté (mâle) Adapter mit Aussengewinde Buisadapter met schroefdraad	65332	FZ 1051			
	Female adaptor threaded Raccord d'accouplement fileté (femelle) Adapter mit Innengewinde Buisadapter met schroefdraad (contra)		FZ 1052			
	Male connector Raccord mâle court Kurzer Verbindungsrippel Korte adapter					Z 669
	Tube adaptor threaded Raccord d'accouplement fileté (mâle), alésé (femelle) Rohrmuffe Buisadapter met schroefdraad moer (contra)		65634			
	Threaded connector Manchon pour rallonge Rohrmuffe Verlengstuk adapter		Z 36			Z 242
	Reinforced coupling Manchon long pour rallonge Verstärkerkupplung Lang verlengstuk		FZ 1054			

Attachments for use with 4 - 10 - 20T hydraulic rams
 Accessoires utilisables avec les vérins 4, 10 et 20 tonnes.
 Zubehör für Ausführungen 4T, 10T, 20T
 Accessoires voor 4, 10, en 20 ton tractie-uitrustingen



	Adjustable extension Rallonge réglage par vis <i>Ausziehbare Verlängerung</i> Verstelbaar verlengstuk			65651	
	Rapid extension Rallonge rapide <i>Schnellverlängerung</i> Snelverlengstuk	Z 651			
	Serrated saddle Tête striée <i>Druckstück, geriffelt</i> Geribbelde kop	65651	Z 34	65637	65167 Z 436
	90°V base Tête en V <i>Prismenaufsatz 90°V</i> 90°V kop	65152		65638	65173 Z 1047
	Flex head Tête caoutchoutée <i>Gummikappe</i> Rubber kop	65178	Z 131 125 mm	65644 65667 125mm 85mm	65180
	"C" clamp Corps de serre-joint <i>Pressbügel</i> Klembeugel		Z 210		Z 220



Wedge head
Tête pied de biche
Keilaufsatz
Klauwhamer kop

65153

**65639 +
FZ 1052**

65639

65166

Z 1046



Ram toe
Pièce d'écartement pour vérin
Zylinderaufsatz
Splijt tractie uitrusting

65155

65169

65169

65169



Flat base
Socle plat
Flache Fussplatte
Platte basis

65156

**65640 +
FZ 1052**

65640

65168



Plunger toe
Pièce d'écartement pour piston
Kolbenstangenauflauf
Splijtuw具 voor zuiger

65154

Z 9A

65642

65172



Ram base
Socle plat pour vérin
Zylindergrundplatte
Platte basis voor tractie

Z 243





Toe lift
Ergot déporté
Heberaster
Uitslaand hefwerk具

Z 595

Attachments for use with 4 - 10 - 20T hydraulic rams
 Accessoires utilisables avec les vérins 4, 10 et 20 tonnes.
 Zubehör für Ausführungen 4T, 10T, 20T
 Accessoires voor 4, 10, en 20 ton tractie-uitrustingen



	Chain pull plate Embase de traction Gerade Kettenplatte Kettingtractie plaat	65346				Z 238
	Chain plate Croisillon de traction pour chaîne Kreuzkettenplatte Kettingtractie		Z 5			
	Chain adaptor Tête à grappin pour vérin tireur Kettenverankerung für Zugzylinder Enterhaak voor tractie		65649			

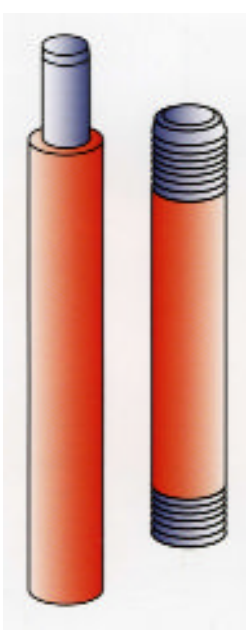

					
75 mm	65157				Z 1041
125 mm	65158	FZ 1002	K 239 900	65165	Z 1042
250 mm	65159	FZ 1003	K 240 900	65164	Z 239
450 mm	65160	FZ 1006	K 241 900	65162	Z 1043
580 mm	65161				
710 mm		FZ 1005	K242900		Z 241

Chains
Chaînes
 Ketten
Kettingen



	AEK539	4t	1500mm	1.5Kg
	EP 122	4t	2700mm	4.5Kg
	AEK 103	10t	600mm	1.6Kg
	AEK 238	10t	1200mm	3.0Kg
	AEK 302	10t	2700mm	7Kg
	AEK 304	10t	4500mm	12Kg
	AEK 307	10t	2700mm	6.5Kg
	AEK 308	10t	1800mm	4.5Kg
	AEK 309	10t	600mm	1.2Kg
	AEK 327	10t	2100mm	5.9Kg
	AEK 328	10t	2100mm	5.9Kg
	Z 218	20t	2400mm	10Kg
	Z 219	20t	3600mm	13Kg

BLACKHAWK®



BLACKHAWK SA

Blackhawk SA (International Sales) BP 5 67026 Strasbourg Cedex - France
Tel: +33 3 88 65 76 30 Fax: +33 3 88 65 76 51 E-Mail: blackhawk-export@snapon.com

Blackhawk SA France - Benelux BP 5 67026 Strasbourg Cedex France
Tel: 03 88 65 76 30 Fax: 03 88 65 76 51 E-Mail: blackhawk-france@snapon.com,
blackhawk-benelux@snapon.com

Blackhawk SA Deutschland Schweiz - Österreich BP 5 67026 Strasbourg Cedex France
Tel: +33 3 88 65 76 30 Fax: +33 3 88 65 76 31 E-Mail: blackhawk-deutschland@snapon.com

Snap-on equipment srl Blackhawk Italia
Via Provinciale Carpi 33 I-42015 Correggio RE - Italy
Tel: 0522 733620 Fax: 0522 733621 E-Mail: blackhawk@snapon.com

Blackhawk reserves the right to make changes in the catalogue at any time • Blackhawk se réserve le droit de modifier à tout moment les caractéristiques indiquées dans ce catalogue •
Technische Änderungen ohne Vorankündigung vorbehalten. • Blackhawk® behoudt zich het recht voor te allen tijde veranderingen in samenstelling van de specificaties door te voeren.

