

BLACKHAWK®



Accessories



Accessoires



Zubehör



Accessoires



Pull Clamps with Bolt

Pinces de traction avec boulon

Zugklammern mit Spannbolzen

Zelfklemmende met klinkbout

AEK 183

Right-angle clamp

Pince pour traction à angle droit

Zugklammer für 2 Zugrichtungen

Tang voor rechthoekige tractie



AEK 236

Pull ring for clamps AEK 232 and AEK 233

Anneau de traction pour pinces AEK 232 et AEK 233

Zugring Zur Verwendung mit AEK 232 und AEK 233

Tractiering voor AEK232 en AEK233 tangen



AEK 232

100 mm pull clamp

Pince à griffes

Zugklammer

Tractietang



AEK 105S

Pull yoke for clamps AEK 183, AEK 232 and AEK 233

Etrier de traction pour pinces autoserrantes AEK 183, AEK 232 et AEK 233

Zugjoch. Zur Verwendung mit AEK 183, AEK 232 und AEK 233

Tractiebeugel voor zelfklemmende tangen AEK183, AEK232, en AEK233



AEK 233

45 mm pull clamp

Pince à griffes

Zugklammer

Tractietang



	100 mm	3,1 kg	24	8 t
AEK 183	100 mm	3,1 kg	24	8 t
AEK 232	100 mm	2,2 kg	24	6 t
AEK 233	45 mm	1,5 kg	24	4 t
AEK 236	-	0,8 kg	-	4 t
AEK 105S	-	0,8 kg	-	10 t

AEK 182S

Swivel clamp

Pince autoserrante*Universalzugklammer***Zelfklemmende tang****AEK 256**

Pull Clamp with pull ring

Mini pince de traction avec anneau*Mini-Zugklammer mit Zugring***Mini tractietang met ring****CL 105**

Compact self-tightening clamp. For one or two pulls in one or two directions. Tall, deep jaw.

Pince autoserrante compacte pour une traction dans une ou deux directions. Mâchoire haute et profonde.*Kompakte selbstschließende Klammer mit Spannbolzen für eine oder zwei Zugmöglichkeiten in eine oder zwei verschiedene Richtungen (für Bleche mit großem Falz).***Compacte zelfklemmende tang voor een tractie in een of twee verschillende richtingen. Hoge en diepe bek.****AEK 245S**

Pull Clamp

Pince de traction*Zugklemme***Tractietang****AEK 185**

Self tightening clamp for minimum space

Pince autoserrante pour espace minimum*Universalzugklammer***Zelfklemmende tang voor minimum ruimte**

AEK 182S	4,1 kg	-	-	M16 x 90	24	8 t
AEK 245S	2,5 kg	-	-	M16 x 70	14 & 24	4 t
CL 105	2,3 kg	-	-	-	-	4 t
AEK 256	1,0 kg	45 mm	42 mm	M12 x 100	19	4 t
AEK 185	4,5 kg	-	-	M16 x 90	24	8 t

Pull Clamps without Bolt

Pinces de traction sans boulon

Zugklammern ohne Spannbolzen

Tractietang zonder klinkbout

AEK 428



Pull clamp with high-resistance right-angle jaw
Pince de traction à mâchoire rapportée de haute résistance
Selbstschließende Zugklammer mit auswechselbaren Zahnleisten
Tractietang met toegevoegde brede bek met hoge weerstand

AEK 430



Pull clamp with wide high-resistance right-angle jaw
Pince de traction à mâchoire rapportée de haute résistance
Selbstschließende Zugklammer mit auswechselbaren Zahnleisten
Tractietang met toegevoegde brede bek met hoge weerstand

AEK 431



Pull clamp with right-angle jaw. The rotation of the pull ring locks the jaws, preventing sliding before the self-tightening device is activated
Pince de traction à mâchoire rapportée. La rotation de l'anneau de traction serre les mâchoires. Aucun glissement avant que le dispositif d'auto-serrage n'intervienne

Selbstschließende Zugklammer. Durch Drehen des Zugringes schliessen sich die Zahnleisten: dadurch kein Abgleiten, bevor die Selbstschliess-Vorrichtung betätigt wird

Tractietang met toegevoegde bek. Op deze tang : knijpt de bek met het draaien van de tractiering. Daardoor geen wegglijden, voordat het zelfklemmende mechanisme in werking treedt

AEK 432



Clamp with self-tightening jaws for chains
Pinces autoserrantes avec crochet pour chaîne
Selbstspannende Klammer mit Kettenhaken
Zelfklemmende tang met haak voor de ketting

AEK 433



Clamp with self-tightening jaws for chains
Pinces autoserrantes avec crochet pour chaîne
Selbstspannende Klammer mit Kettenhaken
Zelfklemmende tang met haak voor de ketting

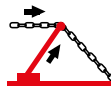

	Width	Weight	Load Capacity
AEK 428	60 mm	3,5 kg	6 t
AEK 430	100 mm	3,8 kg	6 t
AEK 431	60 mm	4,2 kg	8 t
AEK 432	60 mm	3,5 kg	6 t
AEK 433	100 mm	3,8 kg	6 t

EK 402 T



Wedge clamp with self-tightening jaws. Wedge-action jaws grip tighter the harder you pull. Specially for pinch welds

Pince rapide autoserrante (sans boulon de serrage). Spéciale pour tirer sur les lèvres de soudure parallèlement à leur bord

Selbstgreifende Patentklammer. Spezialklammer für das Ausrichten von Schweißfahnen parallel zur Fahrzeugkante

Snelle zelfklemmende tang (zonder aandraai klinkbout). Speciaal voor tractie evenwijdig aan de lasranden

Goes exactly where you want it to

Mise en place à l'endroit voulu, avec exactitude

An der zu ziehenden Kante exakt platzierbar

Plaatsing op gewenste plek, met grote nauwkeurigheid

97200S

Scissor clamp

Pince de traction rapide en ciseaux

Zugzangen

Snelle Tractie schaartang



97401 S

Fast clamp

Pince autoserrante automatique

Zugklammer

selbstschließend

Automatische

Zelfklemmende tang

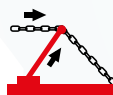

AEK 402 T

1,9 kg

80 mm

4 t

97200 S

3,1 kg

50 mm

4 t

97401 S

3,6 kg

52 mm

6 t

AEK 281



High-Clearance Clamp
Pince à grand dégagement
Ausladende Zugzange
Tang met grote opening

AEK 2810

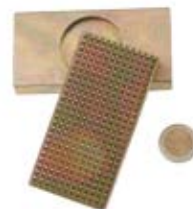

Interchangeable jaws
Mors interchangeables
Austauschbare Spannbacken
Verwisselbare bekken

KIT AEK 28

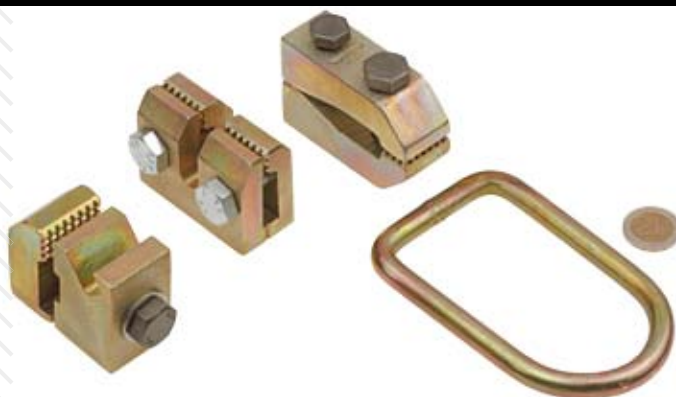

AEK 282



Mini self tightening clamp
Mini pince autoserrante
Mini Zugklammer
Mini zelfklemmende tang

AEK 283



Double jaw
Double mâchoire
Doppelbackenklemme
Dubbele grip

AEK 284



Mini hook
Crampon
Klammer
Kram

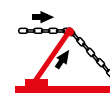
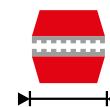
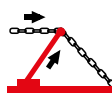
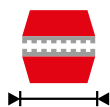

AEK281

16 kg

25 mm

8 t

AEK283

0,75 kg

65 mm

2 t

AEK282

0,75 kg

25 mm

2 t

AEK284

0,75 kg

30 mm

2 t

AEK 102



4 Kg

Chain pull yoke

Étrier de guidage de chaîne pour traction double

Zugjoch für doppelte Zugkombination

Beugel voor kettinggeleider voor dubbele tractie

AEK 235S



2,5 Kg

Eye bolt and pull plate

Plaque d'ancrage avec tige filetée

Zugplatte mit T-Bolzen

Trekplaat met schroefdraad

AEK270S

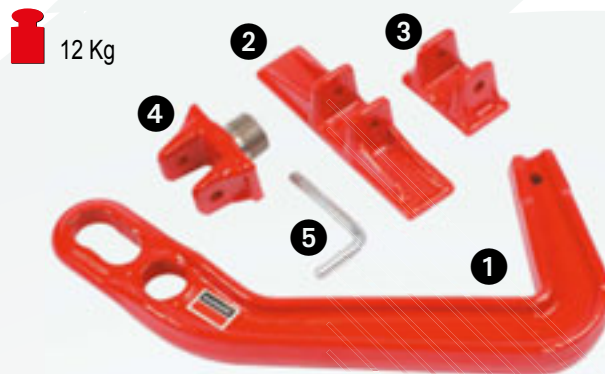

12 Kg

Multi-purpose pull hook / Crampon universel pour traction
Mehrzweckzughaken / Universele kram voor gesteunde

97272



12,7 Kg

Deep body hook. Lightweight

Crampon ultra-léger

Ultraleichter Aluminium-Zughaken

Extra lichte kram

AEK 301



2,2 Kg

Pull plate

Plaque d'amarrage à trous multiples

Zugplatte

Fixeerplaat met meerdere gaten

1 AEK 269S Pull hook / Bras crampon / Zughaken / Kramarm

2 S101B043 Wide plate / Semelle large / Grosse Druckplatte Bede steun

3 S101B044 Narrow plate / Semelle courte / Kleine Druckplatte Korte steun

4 S03A023 Threaded head / Tête filetée / Adaptersattel Kop met schroef Kodraad

5 S061A171 Lock pin / Goupille de verouillage / Verankerungsstift / Sluitpin voor trekplaat

AEK 2000

Pull strap assy
Sangle de traction
Tragband
Trekband

5,8 Kg



AEK 2001

Pull strap assy
Sangle de traction
Tragband
Trekband

0,45 Kg

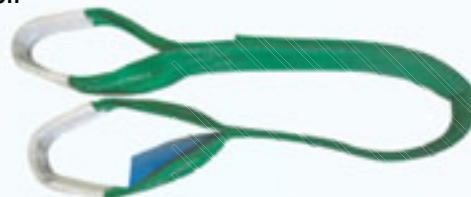

Chains - hooks / Chaînes - crochets Ketten - Haken / Kettingen - Haaken



EP 122		4 t	2700 mm	4,5 kg
AEK 2504		4 t	7500 mm	13 kg
AEK 103		10 t	600 mm	1,6 kg
AEK 238		10 t	1200 mm	4,2 kg
AEK 302		10 t	2700 mm	7,5 kg
AEK 304		10 t	4500 mm	11,5 kg
AEK 307		10 t	2700 mm	6,7 kg
AEK 308		10 t	1800 mm	4,5 kg
AEK 309		10 t	600 mm	4 kg
AEK 327		10 t	2100 mm	5,3 kg
AEK 328		10 t	2100 mm	5,9 kg
Z 218		20 t	2400 mm	11,8 kg
Z 219		20 t	3600 mm	15 kg
HD452A		25 t	3600 mm	22 kg
HD453A		25 t	900 mm	9 kg

	EP 123	AEK332	HD332
Double hook Double Crochet Doppel Haken Dubbele Haak			

EP123	0,7 kg	4 t
AEK332	1 kg	4 t
HD332	3 kg	20 t
97276A	0,7 kg	-
97277A	0,9 kg	-

97276A
"M" hook Crochet "M" "M" Haken "M" Haak

97277A
"J" hook Crochet "J" "J" Haken "J" Haak

AEK 243



1,4 Kg

Double hook for pulling on bumpers, panels, transverse beams, etc.(4T)

Crochet double pour traction sur les parechocs, panneaux, traverses, etc. (4 tonnes).

Zugkette 0,5m mit Laschen (4t).

Dubbele haak voor tractie op bumpers, panelen, dwarsbalken, enz. (4 ton)



AEK99 - HD99* - EP99*

Safety cable

Câble de sécurité

Sicherheitsfangseil

Veiligheidskabel

* Not represented

* **Non représenté**

* *Nicht dargestellt*

* **Niet aanwezig**



1 Kg

97530



450 mm



355 mm



3 kg

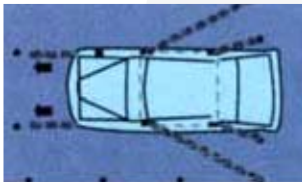

K 830901



3,9 Kg

Push converter

Tête de poussée

Druckumlenklager

Duwinrichting

K 178264



1,7 Kg

Chain lock head for use with :

Pièce de verrouillage pour chaîne avec

goupille, pour utilisation avec :

Kettenumlenklager mit Sicherungsstift zur Anwendung mit :

Kettingslot met pin voor gebruik van:

Power-Pro®, Mitek®, Korek®, Mangusta®.

97605E



Universal pulley. Helps you achieve precise directional control in certain corrective pulls

Poulie indépendante. Complément de tout système de redressage

Lose Umlenkrolle. Ergänzt jedes Richtsystem

Onafhankelijke katrol. Vult elk uitdeuksysteem aan



275 mm



100 mm



75 mm



3,6 kg

AEK 836

Chain tensioner

Kettenspanner

Tendeur avec chaîne

Kettingspanner



4,2 Kg

10 t



AEK 837

Chain tensioner

Kettenspanner

Tendeur avec chaîne

Kettingspanner



5 Kg

10 t



Universal Pull Accessory / **Accessoire universel de traction** / *Universelles Zug-Zubehör* / *Universeel tractieaccessoire*

AEK 2250

Universal Pull Accessory for McPherson Struts
Accessoire universel de traction pour les têtes de fixation McPherson
Universelles Zug-Zubehör für Federbeinaufnahmen
Universeel tractieaccessoire voor McPherson bevestigingskoppen



 9,1 Kg

DOOR APERTURE HOLDING AND RE-FORMING ACCESSORIES / VÉRINS MÉCANIQUES ET ÉTAIS
MECHANISCHE SPANNWERKZEUGE / MECHANISCHE VIJZELS EN STUTTEN

AEK 110

Twin link restraint
Double étais universel pour entrées de portes  11,5 Kg
Doppel-türspanner
Dubbele universele deurspanner



AEK 111



 4,5 Kg

Push-Pull clamps. Can be attached to push or pull rams and used for precise aperture re-formation (pair). Used with FZ1051 and 65634.

Pincas pour entrées de portes adaptables sur vérin fileté (paire). Utiliser les raccords FZ1051 et 65634

Paar Schrubklemmen für Türspanner für Zylinder mit Gewinde für Zylinder-Adapter FZ1051 und 65634 verwenden

Schroefklemmen voor deurspanner aanpasbaar (per paar) de FZ1051 en 65634 aansluitingen gebruiken

Support Stands / Chandelles / Unterstellböcke / Onderbouwsteunen

AEK 832

Roller Stand

Chandelle à rouleaux

Rollerbarer Unterstellbock

Mobiele Onderbouwsteun



AEK 833

Ajustable support stand

Chandelle ajustable

Höhenverstellbare

Unterstellbock

Afstelbare onderbouwsteun



96486

Roller Stands

Chandelles de diagnostic à rouleaux

Rollerbarer

Unterstellböcke

Mobiele

Onderbouwsteunen



STA15

Support stands
for STL 3000

Chandelles de diagnostic pour STL 3000

Unterstellböcke für STL 3000

Onderbouwsteunen voor STL3000



VEHICLE STANDS / CHANDELLES À CRÉMAILLÈRE UNTERSTELLBÖCKE / ASSTEUNEN

67703



67706

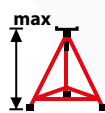
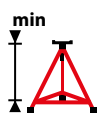
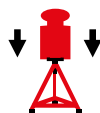
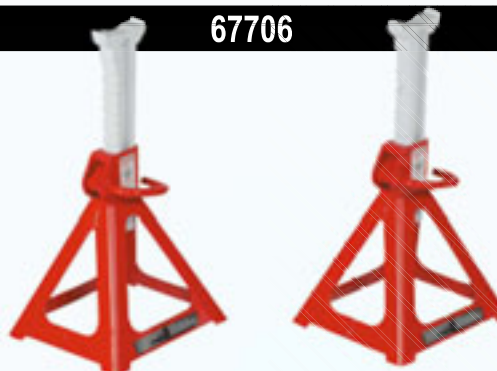

AEK 832

1500 Kg

664 mm

820 mm

521 mm

9 Kg

AEK 833

1500 Kg

615 mm

700 mm

416 mm

9 Kg

96486

1200 Kg

1400 mm

1400 mm

700 mm

160 Kg

STA15

800 Kg

1106 mm

1106 mm

700 mm

100 Kg

67703

2722 Kg

298 mm

435 mm

190x222 mm

12,7 Kg

67706

5443 Kg

403 mm

622 mm

254x305 mm

20,3 Kg

Anchor Pots / Puits d'ancrage Ankertöpfe / Verankerpot

TD 130E



2,3 Kg

Ø 89 mm

Anchor pots with chain slot for use with Power Post® pulling tower

Puits avec encoche, à utiliser avec tour de traction Power Post®

Ankertopf mit Kettenaufnahme zum Verankern von 10T Power Post® Zugturm

Pot met kettinginkeping, te gebruiken met Power Post® tractietoren

TD 135E



3,3 Kg

Ø 89 mm

Anchor pots with chain slot for use with Power Post®

Puits avec encoche, à utiliser avec tour de traction Power Post®

Ankertopf mit Kettenaufnahme zum Verankern von 10T Power Post® Zugturm

Pot met kettinginkeping, te gebruiken met Power Post® tractietoren

TD 330E



8 Kg

Ø 127 mm

Anchor pots with chain slots with larger diameter for use with King Power Post® and Maxi Tower pulling towers

Puits avec encoches pour chaînes plus larges, pour utilisation avec les tours King Power Post® et Maxi Tower

Ankertöpfe mit Einschnitten für breitere Ketten, zur Verwendung mit King Power Post® und Maxi Tower

Pot van voor anker gaan met encoches voor meer algemene ketens, voor gebruik met de omloop King Power post® en Maxi Tower

TD 335E



8 Kg

Anchor pots with chain slot for use with Power Post®

Puits avec encoche, à utiliser avec tour de traction Power Post®

Ankertopf mit Kettenaufnahme zum Verankern von 10T Power Post® Zugturm

Pot met kettinginkeping te gebruiken met Power Post® tractietoren



Ø 127 mm

AFM 8104



2,9 Kg

Threaded anchor pots for use with Power Lok or Cab Bench leg anchoring

Puits de filetage, à utiliser avec fixation du Power Lok ou pieds du Cab Bench

Ankertopf mit Schraubgewinde zum Verankern von Power Lok oder Cab Bench Fahrerhaus-Richtbank

Pot met schroefdraad, te gebruiken met bevestiging van Power Lok of Cab Bench arm



Ø 89 mm

BST201

Slide Hammer
Marteau à inertie
Zughammer
Traagheidshamer



6,4 Kg

BST13



Ratchet wrench
Clé pneumatic d'angle
Luftschrauber
Pneumatische sleutel



1,2 Kg

STM26



Trolley with two clamps
Chariot de déplacement
Rollwagen zum Verschieben von Karrosserien
Transportwagen met klem verankering



38 Kg

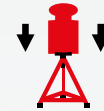

1200 Kg

ENGINE HOLDER / TRAVERSE DE SOUTIEN
MOTORTRÄGERBRÜCKE / MOTORSTEUNBALK

B024

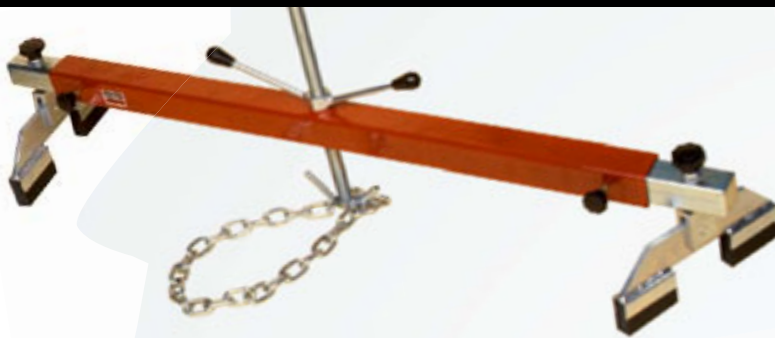

Adjustable engine holder
Traverse réglable de soutien moteur
Verstellbare Motorträger-Brücke
Instelbare steunbalk voor motorondersteuning



14 Kg



500 Kg

SPOT WELD DRILL BIT GRINDER / AFFÛTEUSE DE FORETS À DÉPOINTER
BOHRER - SCHLEIFMASCHINE / SLIJPMACHINE VOOR LASPUNTBOREN

BST 1000 K



30 sharpenings }
30 affûtages
30 schleifvorgänge
30 slijpingen

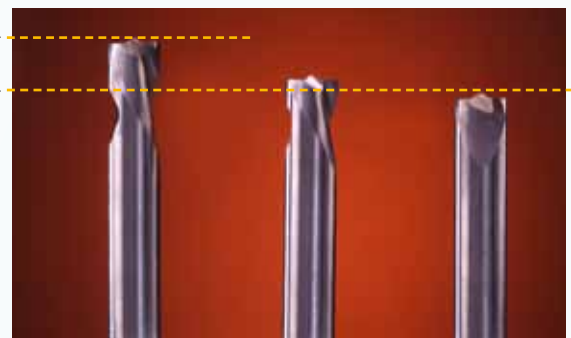

230 V, 50/60 Hz



10 Kg



185 mm



210 mm

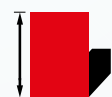

230 mm

Measuring gauges / Piges de mesure Meßlehren / Meetstaven

High quality, accurate and very easy to use,
German and Swiss production.

Haute qualité, grande précision, maniables, très légères,
fabrication Suisse et Allemande.



Qualitativ hochwertig, präzises Arbeiten, leichte Handhabung, geringes Gewicht, deutsch-schweizerisches Fabrikat.
Hoogwaardige kwaliteit, grote nauwkeurigheid, handzaam, zeer licht van gewicht, van Zwitserse en Duitse makelij.

AEK 119



Telescopic Gauge with accessories for comparative measuring
Pige télescopique avec accessoires pour mesures comparatives
Teleskopische Meßlehre mit Zubehör für vergleichende Messungen
Telescopische meetstaal met toebehoren voor vergelijkende metingen

 1,450 Kg

 415 mm
 2600 mm

AEK 329

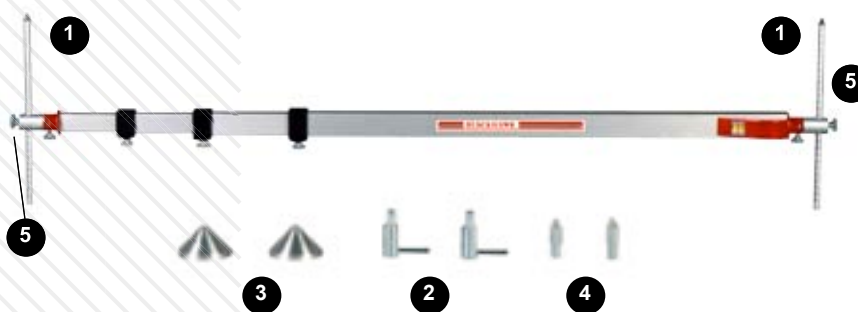



Telescopic Gauge with accessories for comparative measuring

Pige télescopique avec accessoires pour mesures comparatives

Teleskopische Meßlehre mit Zubehör für vergleichende Messungen

Telescopische meetstaal met toebehoren voor vergelijkende metingen

 2 Kg

 920 mm
 2600 mm

AEK 419

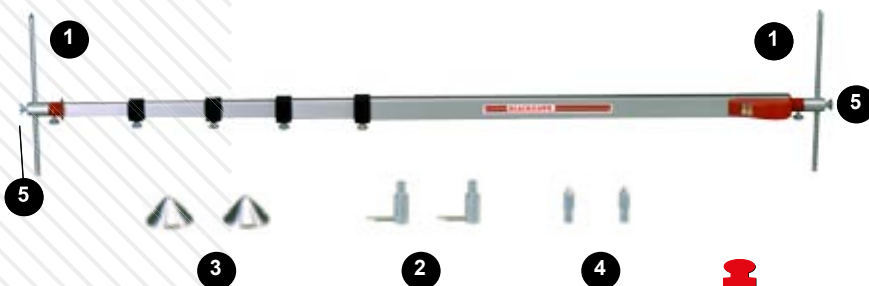



Telescopic Gauge with accessories

Pige télescopique avec accessoires

Teleskopische Meßlehre mit Zubehör

Telescopische meetstaal met toebehoren

 2,3 Kg

 950 mm
 3250 mm

	AEK 119	AEK 329	AEK 419
1	F 13820	2	2
2	F 13790	2	2
3	F 21900	2	2
4	F 17870	2	2
5	F 19790 + F 16450	2	2

Digital measuring gauges / Piges de mesure télescopiques / Teleskopisches Meßlehren / Teleskopische Meetstaven

TECH TRAM (400 - 2665 mm)

TECH TRAM is a telescopic digital measuring gauge, very easy to use and allowing quick controls of measuring points.

TECH TRAM est une pige de mesure télescopique à affichage digital, très simple d'utilisation et permettant d'effectuer des contrôles rapides.

TECH TRAM ist ein sehr einfaches Gerät zu bedienendes teleskopisches Prüf- und Diagnose zur schnellen Durchführung von Prüfungen.

TECH TRAM is een telescopische meetlat met digitale aanduiding, zeer eenvoudig te bedienen voor snelle controles.

MGE10 - MGE12



Version on metal tool panel + USB key
Version murale + clé USB
 Wandversion + Stick
Voor muurbevestiging + Stick

MGE11 - MGE13



Version in carrying case + USB key
Version en mallette aluminium + clé USB
 Version mit Aluminiumkoffer + Stick
Met aluminium opbergkoffer + Stick

MGE1012



1 year update
1 an mise à jour
 1 Jahr Update
 1 jaar update

MGE12 = MGE10 + MGE1012

MGE13 = MGE11 + MGE1012

Données caractéristiques
 Nom: CARROSSERIE DE LA TOUR
 Adresse: RUE DE L'ESPERANCE
 Ville: TOURNAI
 Code postal: 0660
 Téléphone:
 Fax:
 E-mail:
 web:

Client
 Person: ALEX MALLER
 Adresse: RUE DU MUSÉE
 Ville: STRASBOURG
 Code postal: 67000
 Téléphone:
 Fax:
 E-mail:
 web:

Commande
 Order: 13
 N° Facture:
 Date: 03/12/2012
 Date réparation: 03/12/2012
 N° personnel: 0
 Comp. Adresse:

Vehicule
 Marque: SEAT
 Modèle: 5 SERIES (P11 - P14) Sedan, 4
 Door

Plan de montage
 Date: 2013

N°	Date	Marque	L (mm)	H (mm)
28-4	2181	0	-2181	200
27-4	2342	0	-2342	
28-3	2342	0	-2342	
27-3	2181	0	-2181	200
28-27	800			



BLACKHAWK®



Length
Longueur
Länge
Lengte



Width
Largeur
Breite
Breedte

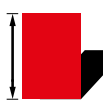

Height
Hauteur
Höhe
Hoogte



Weight
Poids
Gewicht
Gewicht



Opening capacity
Capacité d'ouverture
Öffnungsweite (Höhe)
Opening Capaciteit

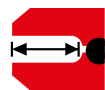

Depth
Profondeur
Tiefe
Diepte



Bolt
Boulon
Bolzen
Klinkbout



Spanner
Clef
Maulschlüssel
Sleutel

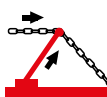

Pulling force
Force de traction
Zugkraft
Tractiekracht

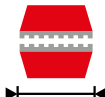

Width of jaw
Largeur des mâchoires
Breite der Backen
Breedte van de bekken

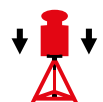

Maximum load
Charge maximale
Höchstbelastung
Maximale besleesting



Lifting capacity
Capacité de levage
Hebeleistung
Hefe capaciteit

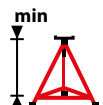

Minimum height
Hauteur mini
Mindesthöhe
Minimale hoogte

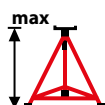

Maximum height
Hauteur maxi
Maximale Höhe
Maximale hoogte



Base dimensions
Dimension de base
Basisabmessungen
Basisafmetingen



Voltage
Voltage
Spannung
Voltage

BLACKHAWK SA

France - Benelux : BP 5 - 67026 Strasbourg Cedex - FRANCE

Tél. 03 88 65 76 30 - Fax 03 88 65 76 31 - E-Mail : info@blackhawk.fr - www.blackhawk.fr

International Sales : BP 5 - 67026 Strasbourg Cedex - FRANCE - www.blackhawk.fr

Tel. +33 3 88 65 76 29 - Fax +33 3 88 65 76 51 - E-Mail : export@blackhawk.fr

Deutschland- Schweiz - Österreich : BP 5 - 67026 Strasbourg Cedex - FRANCE

Tel. +33 3 88 65 76 52 - Fax +33 3 88 65 76 31 - E-Mail : info@blackhawk.de - www.blackhawk.de

SNAP-ON EQUIPMENT SRL - BLACKHAWK ITALIA :

Via Provinciale Carpi 33 - I-42015 Correggio - RE - ITALY

Tel. 0522 733620 - Fax 0522 733621 - E-Mail : blackhawk@snapon.com - www.blackhawk.it

SNAP-ON EQUIPMENT - BLACKHAWK UK :

48 Suttons Park Avenue - Reading RG6 1AZ - UK

Tel. 01303 270273 - Fax 01303 270274 - Email: sales@blackhawk.co.uk - www.blackhawk.co.uk

Blackhawk reserves the right to make changes in the catalogue at any time • Blackhawk se réserve le droit de modifier à tout moment les caractéristiques indiquées dans ce catalogue •
Technische Änderungen ohne Vorankündigung vorbehalten. • Blackhawk® behoudt zich het recht voor te allen tijde veranderingen in samenstelling van de specificaties door te voeren.

